

HYUNDAI

POWER PRODUCTS

5-IN-1 PETROL MULTI-TOOL HYMT5200X-1

Instruction Manual



Scan to access the
website and alternative
languages



GENUINE PRODUCT OF
HYUNDAI CORPORATION

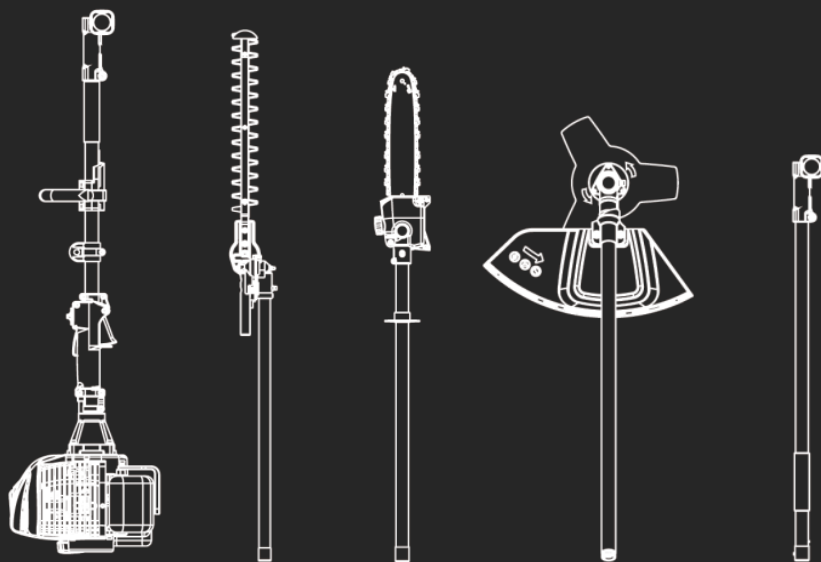

WARNING: Read the instructions carefully before use.

Iss:Jan/25

Contents

Introduction	3	Operation	34-43
Safety Information	4-13	Connecting The Extension Boom.....	34
Understand Your Machine.....	4	Using The Extension Boom.....	34
Personal Safety.....	4-5	Using The Grass Trimmer.....	35
Inspect Your Machine.....	5	Using The Pole Saw.....	36-37
Work Area.....	5	Using The Cutting Blade.....	38
During Use.....	6-9	Using The Hedge Trimmer.....	39
Pole Saw Safety.....	10	Re-Filling The Trimmer Line.....	40-41
Hedge Trimmer Safety.....	10	Starting/Stopping Procedure	42-44
Grass Trimmer Safety.....	10	Cold Start.....	42-43
Brush Cutter Safety.....	10	Warm Start.....	43
Engine Safety.....	11	Stopping The Engine.....	44
Carbon Monoxide.....	12	Maintenance	45-57
Fuel Safety.....	13	Maintenance Safety.....	45
General Safety.....	13	Checking Your Machine.....	45
Spilled Fuel.....	13	Cleaning.....	46
Fueling/De-Fueling.....	14	General Cleaning.....	46
Storage.....	14	Cleaning The Pole Saw.....	46
Vibrations.....	15	Cleaning The Hedge Trimmer.....	46
Noise.....	15	Storage.....	47
Intended Use.....	16	Short Term Storage.....	47
Personal Protective Equipment.....	17	Long Term Storage.....	47-48
Symbols On The Machine.....	18-20	Preparation To Re-Use.....	48
Unboxing	21	Transportation.....	48
In The Box	22	Pole Saw Oil.....	49
Features	23	Pole Saw Chain Sharpening.....	49
Assembly	24-30	Air Filter.....	50
Assembly Overview.....	24	Spark Plug.....	51
Attach Engine Unit Handle.....	24-25	Lubricating The Gears.....	52
Cutting Blade Attachment.....	25-26	Lubricating The Saw Chain.....	53
Lower Guard Assembly.....	27	Tightening And Checking The Saw Chain.....	54
Grass Trimmer Head Assembly.....	27	Pole Saw Maintenance Schedule.....	55
Pole Saw Attachment Assembly.....	28-30	Hedge Trimmer Maintenance Schedule.....	55
Using The Harness.....	30	Troubleshooting	56
Preparation	31-32	Technical Data	57-60
Before Each Use.....	31	Recycling And Disposal	61
Fuel And Oil.....	32	Declaration Of Conformity	62
Fuel Safety	33	Notes	63
		Useful Information	64
		Product Record	65
		Contact Us	66

Introduction

Thank You For Purchasing Your HYUNDAI Product

We work very hard to give all of our customers the best possible service. If you have any problems, before leaving negative feedback, please contact us to give us a chance to resolve the issue. We would be delighted if you left us positive feedback! Thank you for purchasing this product.

Important!



WARNING: READ THE INSTRUCTION BOOKLET THOROUGHLY BEFORE USING THE MACHINE. Keep for future reference and pass it on if the machine is loaned or sold to another user.

This manual has been produced by Hyundai Power Products and should be kept with the product. Please read and understand these instructions before you use your product. Failure to do this may result in personal injury or damage to the product.

The safety precautions and warnings are to ensure your safety and protect you from harm or damage to the product.

The information contained in this manual was accurate at the time of production, however HYUNDAI Power Products may make modifications to the product without notification.

These are the original product instructions. This document is part of the product; retain it for the life of the product, passing it on to subsequent holders. Read this manual in full before attempting to assemble, operate or maintain this product.

This manual describes the purpose of the product and contains all the necessary information to ensure its correct and safe use. Following all the instructions and guidance in this manual will ensure the safety of both the product and the operator and increase the lifespan of the product.

All photographs and drawings within this manual are to help illustrate correct operation of the product. Every effort has been made to ensure the information contained in this manual is accurate. However, we reserve the right to amend this document without

Safety Information

Understand Your Machine

- **WARNING!** You must read these instructions carefully before operating the machine. Make sure that you are familiar with the controls and properly operate the machine. You must learn how to stop the machine quickly. If you do not follow the warnings and instructions, it may result in fire and/or serious injury. Make sure to save all warnings and instructions for future reference.
- Read this manual and labels affixed to the machine to understand its limitations and potential hazards.
- Be thoroughly familiar with the controls and their proper operation. Know how to stop the machine and disengage the controls quickly.
- If the unit is to be used by someone other than original purchaser, or is to be loaned, rented, or sold, always provide this manual and any needed safety training before operation. The user can prevent and is responsible for accidents or injuries that may occur to themselves, to other people, or to property.
- Do not force the machine beyond its limits. Use the correct machine for your application.
- Know how to stop the machine quickly in case of emergency. Understand the use of all controls.
- ALL MAINTENANCE other than that listed in this manual, should be carried out by professionally trained and certified personnel.
- When using this machine for the first time and before actual work, you **MUST** learn how to handle the machine from an experienced or skilled person.

Personal Safety

- **WARNING!** Never allow children or people unfamiliar with these instructions to use the product. Local regulations can restrict the minimum age of the operator.
- Keep children, pets, and other people not using the unit away from the work area (at least 15m). Be alert and shut off the unit if anyone enters work area. Keep children under the watchful care of a responsible adult.
- Stay alert, watch what you are doing and use common sense when operating the machine. Never operate the machine when unwell or tired, or if you have taken alcohol, medicine, drugs or any substances which may slow your reflexes and compromise judgment. A moment of inattention while operating the machine may result in serious personal injury.
- Appropriate Personal Protective Equipment (PPE), **MUST** be worn at all times when operating or repairing the machine. Always wear anti-slip and resistant work footwear and long trousers while using the machine. Do not use the machine when barefoot, wearing sandals or similar lightweight footwear. Do not wear chains, bracelets or clothing that is loose fitting or hanging ties or cords. Tie long hair back. Always wear protective earplugs. Loose clothes, jewellery, or long hair can be caught in moving parts. Protect eyes, face, and head from objects that may be thrown from the unit. Always wear safety goggles or safety glasses with side shields when operating.
- Always keep hands and feet away from all moving parts during operation. Moving parts can cut or crush body parts. Always keep hands and feet away from all pinch points.

Safety Information

Personal Safety (Continued)

- Do not touch parts that might be hot from operation. Allow parts to cool before attempting to maintain, adjust, or service.
- Do not overreach. Keep proper footing and balance at all times. This enables better control of the machine in unexpected situations. Extending your body too far can result in a loss of balance and you may fall which will result in injury.
- Never place any part of your body where it would be in danger if movement should occur during assembly, installation, and operation, maintenance, repairing or moving.
- Keep in mind that the operator or user is responsible for accidents, hazards or unexpected events involving the machine that occur to other people or their property. It is the responsibility of the user to assess the potential risk of the area where work is being carried out. The operator or user must take all necessary precautions to ensure their own safety and that of others, especially on slopes or rough, slippery and unstable ground.

Inspect Your Machine

- Check your machine before starting it. Keep guards in place and in working order. Make sure all nuts, bolts, etc., are securely tightened.
- You must check the general condition of the machine before use.
- Never operate the machine when it is in need of repair or is in poor mechanical condition. Replace damaged, missing, or failed parts before using it. Check for fuel leaks. Keep the machine in safe working condition.
- Do not use the machine if the machine's switch does not turn off the machine when running. Any machine that can't be controlled with the switch is dangerous and must be replaced.
- Regularly check to see that keys and adjusting wrenches are removed from the machine area before starting it. A wrench or a key that is left attached to a rotating part of the machine may result in personal injury.
- If the machine should start to vibrate abnormally, stop the machine and check immediately for the cause. Vibration is generally a warning sign of trouble.
- Avoid accidental starting. Be sure the switch is off before transporting the machine or performing any maintenance or service on the unit. Transporting or performing maintenance or service on a machine with its switch on invites accidents.
- Do not tamper with or disable safety systems.
- Only use manufacturer-recommended attachments.
- Before using, always visually inspect to see that the tools are not worn out or damaged. Replace worn out or damaged elements and bolts in set to preserve balance.
- Keep the machine in good operating condition. Operating the machine in poor or questionable condition could result in serious injury.
- Be sure all safety devices are in working order and warning labels are in place. These items are installed for your safety.

Safety Information

Work Area

- You must only work in daylight or with good artificial light in good visibility conditions. Do not work at night, at times of heavy fog, or at any other times when your field of vision might be limited and it would be difficult to gain a clear view of the area.
- Keep people, children and animals away from the working area.
- Operate on flat, level ground.
- DO NOT work on wet ground. If there has been heavy rain on the working site, wait until the ground has dried up.
- Never park the machine in a place with unstable ground which could give way.
- You must be careful near ravines, ditches or embankments.
- Exercise extreme caution when operating on or crossing gravel drives, walks, or roads. Stay alert for hidden hazards or traffic.
- Do not work in the rain, when there is a thunderstorm or lightning risk, at times of strong or gale force winds, or at any other times when the weather conditions might make it unsafe to use this product. If there is bad weather conditions, do not use the machine.
- Make sure you thoroughly inspect the entire work area and remove all objects and anything that could be thrown by the machine or could damage the machine (branches, stones, wire, toys, etc). Attempting to clear the work area whilst using the machine will reduce your concentration and creates a trip hazard. Any liquid spilled on the floor may result in you slipping.
- Find and locate all fixed objects in the ground, such as sprinkler systems, poles, water valves, bases for washing lines etc. Make sure that you check for hidden electrical cables or similar on the surface of the lawn. ALWAYS run the machine around these objects. NEVER run the machine over foreign objects.
- DO NOT operate power tools in explosive atmospheres, such as in the presence of flammable liquids, gases or dust. Power tools may create sparks, which may ignite the dust or fumes.
- This machine is only for outdoor use.

Safety Information

During Use

- Always hold the unit with both hands when operating. Keep a firm grip on the handlebars
- Do not operate the machine in confined areas where there may be a risk of crushing the operator between the machine and another object.
- Walk, never run with the machine.
- **WARNING!** If something breaks or an accident happens whilst working, you must turn off the engine immediately and move the machine away to prevent further damage. If an accident happens with injuries or third parties are injured, carry out the first aid measures most suitable for the situation immediately and contact the medical authorities for any necessary health care.
Carefully remove any debris that might cause damage or harm persons or animals should it not be seen.
- Never operate the machine at a fast pace.
- The excessive speed of movement or the absence of maintenance have a significant influence on noise emissions and vibrations. It is necessary to take preventive steps to eliminate possible damage due to high levels of noise and stress from vibration. You must maintain the machine well, wear ear protection and take breaks from working.
- After striking a foreign object, stop the engine immediately, remove the spark plug cap and inspect the machine thoroughly for damage. Repair the damage before continuing.
- Always disengage the levers, turn off the engine, and remove the spark plug, when the unit is left unattended.
- Never attempt to make any adjustments, while the engine is running.
- Never attempt to move the machine in any way other than intended for normal use while the engine is running.
- You must disengage the blade, switch off the engine and unplug the spark plug cable (making sure that all moving parts are stationary):
 - Before refuelling.
 - After striking a foreign object, you must inspect the machine for damage and make repairs before using it again.
 - Before cleaning, checking or working on the machine.
 - Before clearing blockages.
 - When transporting the machine.
 - Whenever you leave the machine unattended.
- Never use the appliance while standing on a ladder.
- Do not use the appliance near power lines. Maintain a minimum distance of 10m to above ground power lines.

Safety Information

During Use (Continued)

Be aware of your environment and all possible hazards that you may be unable to hear while using the machine.

- Keep an eye not only on the branches being cut, but also on fallen material, to avoid tripping.
- Hold the power tool only by the insulated grips as the cutting blades could come into contact with hidden power lines. Contact between the blades and a live wire may make exposed metal parts of the power tool live and could give the operator an electric shock.
- Keep your hands away from the cutting blades. Do not attempt to clear clippings or hold onto the material to be cut while the blades are still in motion. Remove any jammed clippings only when the appliance has been switched off. A moment of inattention while operating the hedge trimmer may result in serious personal injury.
- Wait until the tool has come to a standstill before putting it down.
- After making settings to the working angle, check whether both setting levers are clicked firmly into place. If one of the setting levers remains open, the second could be unintentionally be released by a branch and the cutter bar could swing down.
- Always ensure that the handles are dry and clean and that no petrol mixture is present.
- Do not touch the exhaust.
- Always hold the appliance with both hands. Your thumbs and fingers should encircle the handles.
- Do not cut any wood that is lying on the ground and do not attempt to saw roots that are protruding from the soil. Avoid immersing the saw chain in the soil at all costs, as this could blunt the saw chain.
- Do not use the appliance unless the appropriate protective guard has been installed and is in good condition.
- When starting and operating the appliance, ensure that it does not come into contact with the ground, stones, wire or other foreign material. Switch off the appliance before you put it down.

Safety Information

During Use (Continued)

- The cutting blade flings objects and soil with great force. These can blind or cause other injuries. Wear eye, face and leg protection. Always remove objects from the work area before using the cutting blade.
- The cutting blade continues running after the throttle lever has been released. A running-down cutting blade can inflict cuts to yourself or other people standing nearby. Turn the engine off and make sure that the cutting blade has come to a complete stop before performing any work on the cutting blade.

Safety Information

Pole Saw Safety

- To avoid injuries due to falling branches, do not stand under the branches that you want to cut off. Be aware of branches that may spring back and cause injuries. Work at an angle of approximately 60°.
- Be aware that an appliance kickback can occur.
- Keep an eye not only on the branches being cut, but also on fallen material, to avoid tripping.

Hedge Trimmer Safety

- While trimming, ensure that you do not come into contact with objects such as fence wire or plant supports. They could cause damage to the cutter bar. Inspect the hedge to be cut carefully and remove any wires or other foreign bodies.
- Never touch the cutter bar of the hedge trimmer.
- Never grasp the hedge trimmer by the safety guards.
- Between tasks or after completion of a task, do not set the cutter bar down on its tip as this could cause damage to the cutter bar.

Grass Trimer Safety

- Always use the enclosed shoulder strap.
- Before starting the engine, make sure that the strimmer is not in contact with any obstacles.
- Guide the grass trimmer to the desired height. Avoid contact with small objects (e.g. stones) when using the trimmer.
- Always hold the trimmer on the ground when the appliance is in operation.
- The relevant plastic protective guard for the cutting blade or filament operation must be installed when working with the appliance in order to prevent objects from being flung away.

Brush Cutter Safety

- When working with the 3-tooth cutting blade there is a risk of kickback if the blade strikes against solid obstacles (tree trunks, branches, tree stumps, rocks or similar). This will result in the cutting tool being catapulted back against the direction of rotation. This can lead to the loss of control of the appliance. Do not use the cutting blade near fences, metal posts, boundary stones or foundations.

Safety Information

Engine Safety

- This machine is equipped with an internal combustion engine. Do not use on, or near, forest-covered or brush-covered land unless the exhaust system is equipped with a spark arrester meeting applicable local, state, or federal laws.
- A spark arrester, if used, must be maintained in effective working order by the operator.
- Never start or run the engine inside a closed area. The exhaust fumes are dangerous, containing carbon monoxide - an odourless and deadly gas. Only operate this unit in a well-ventilated outdoor area. (See carbon monoxide safety).
- Do not tamper with the engine in an effort to get it to run at higher speeds. The maximum engine speed is pre-set by the manufacturer and is within safety limits.
- Keep a fire extinguisher on hand when operating this machine in dry areas as a precautionary measure.
- Never leave the operating position when the engine is running.
- The engine parts get very hot when running, do not touch. Danger of burns.
- Follow the instructions to ignite the engine carefully whilst keeping feet away from moving parts.
- Never incline the machine during ignition. Ignite the machine on a flat surface without obstacles or high grass.
- Do not over-rev the engine or change the engine settings.
- Never pick up or carry the machine while the engine is running.
- Stop the engine whenever you leave the machine, or before refuelling, when cleaning or while maintaining.
- Reduce the throttle setting during engine shut down and, if the engine is provided with a shut-off valve, turn the fuel off at the conclusion of working.
- Do not tilt the lawnmower when starting the engine.

Safety Information

Carbon Monoxide

DANGER

Engine exhaust fumes contain Carbon Monoxide. This is a poisonous gas and can kill in minutes. NEVER use inside a building or in an area with poor ventilation. NEVER use inside a confined space, such as but not limited to a house, garage, vehicle, boat or tent. ONLY use outside and far away from windows, doors and vents.

CARBON MONOXIDE IS A COLOURLESS, ODOURLESS GAS. INHALING THIS GAS CAN CAUSE DEATH OR SERIOUS LONG-TERM HEALTH PROBLEMS SUCH AS BRAIN DAMAGE.

Never operate the engine in a confined space where dangerous carbon monoxide fumes can develop. All ignition operations have to be performed in an open or well-ventilated area. Always remember that exhaust fumes are toxic.

The symptoms of carbon monoxide poisoning can include but are not limited to the following; Headaches, dizziness, nausea, breathlessness, collapsing or loss of consciousness.

Carbon monoxide poisoning symptoms are similar to flu, food poisoning, viral infections and simply tiredness. It is quite common for people to mistake this very dangerous poisoning for something else.

To avoid carbon monoxide poisoning DO NOT use Petrol/Diesel powered equipment inside any of the following; Home, garage, tent, camper van, mobile home, caravan or boat. DO NOT use in an enclosed area or moving vehicle. This list is not exhaustive and if you are in any doubt contact your dealer.

If you think you have or someone around you has been affected by carbon monoxide poisoning;

Get them fresh air immediately, by leaving the affected area or by opening doors and windows. If safe and practical to do so make sure that the machine is turned off. DO NOT enter a room you suspect of having carbon monoxide present – instead call the emergency services.

Contact a Doctor immediately or go to Hospital – let them know that you suspect carbon monoxide poisoning.

Safety Information

Fuel Safety



CAUTION! ALL FUELS ARE HIGHLY FLAMMABLE AND PETROL VAPOUR IS EXPLOSIVE. TAKE EXTREME CARE WHEN HANDLING FUEL. KEEP FUEL OUT OF REACH OF CHILDREN.

General Safety

Do not smoke each time fuel is handled.

- ALWAYS avoid inhaling fumes.
- ALWAYS carry fuel in the correct and clearly marked container.
- ALWAYS wear correct, suitable and fit for purpose Personal Protective Equipment (PPE), suggested items are, but not limited to, safety gloves and overalls.
- To avoid sparking or arcing, keep grounded conductive objects – such as tools – away from exposed, live electrical parts and connections. These events could ignite fumes or vapours.
- Do not operate the machine with known leaks in the fuel system.
- Fire hazard - keep fuel away from all sources of ignition for example heaters, lamps, sparks from grinding or welding.
- DO NOT carry out hot work on tanks that have contained fuel.
- ALWAYS keep the work area tidy.
- ALWAYS dispose of waste fuels correctly.
- Serious personal injury can occur when petrol is spilled on yourself or your clothes. Rinse your skin and change your clothes immediately.

Fuel Information

Using E10 Petrol Important: This product must be used with high-quality unleaded fuel ONLY. ALWAYS use automotive petrol/gasoline suitable for four-stroke engines; DO NOT mix fuel and oil. It is recommended to use E10 (95 RON) automotive fuel, with an appropriate additive or stabiliser in this product. Damage caused by failure to add fuel or using incorrect or poor-quality fuel is not covered by your warranty. CAUTION! E10 petrol is hygroscopic and attracts moisture, which may damage the fuel system if stored in the product for more than four weeks. After draining the fuel tank, always run the engine until the last of the fuel in the system is spent and drain the float bowl when the engine is cool. E10 petrol should be used within 30 days of purchase. Some petrol brands contain other quantities of ethanol. DO NOT use fuels with more than 10% ethanol in your Genpower product. Always store and dispose of fuels responsibly and in accordance with local regulations.

Spilled Fuel

- If you have spilled fuel, make sure you do not attempt to ignite the engine. Move the machine away from the area of spilled fuel and avoid creating any source of ignition until the fuel has evaporated and fuel vapours have dissipated.
- When fuel is spilled on yourself or your clothes, wash your skin and change clothes immediately.
- ALWAYS clean up spills promptly using absorbent granules and a lidded bin.

Safety Information

Fueling/De-Fueling

- ALWAYS fuel and de-fuel in a well ventilated area outside of buildings. Use a funnel to add fuel to the fuel container – only outdoors. Do not smoke during this and each time fuel is handled.
- Add fuel before igniting the engine. Never remove the fuel tank cap or add fuel whilst the engine is running or when it is hot.
- When de-fueling, ALWAYS use a proper fuel retriever.
- Never overfill the fuel tank. Engine heat can cause fuel to expand, never fill the tank to more than 1/2" below the bottom of the filler neck. This will provide space for fuel expansion.
- When refilling or draining the fuel tank, use an approved fuel storage container. This needs to be actioned in a clean, well-ventilated outdoor area. While adding fuel or operating the unit, do not smoke, and stay away from sparks, open flames, or other sources of ignition near the area of operation.
- Always stop the engine and allow it to cool before filling the fuel tank. Never remove the cap of the fuel tank or add fuel while the engine is running or when the engine is hot.
- Loosen the fuel tank cap slowly to relieve any pressure in the tank.
- ALWAYS keep the handles dry, clean and free of oil and fuel. Clean regularly.
- After fueling, ensure the cap is firmly tightened and secure.
- Never use the lock-function when filling with fuel.
- Open the fuel tank slowly in order to allow any pressure which may have built up in the tank to dissipate. To prevent the risk of fire, move at least 3 metres away from the refuelling area before starting the appliance.

Storage

- Store fuel in containers specifically designed and approved for fuel storage.
- Store fuel in a cool, well-ventilated area, safely away from sparks, open flames, or other sources of ignition.
- Never store fuel – or a machine with fuel in the tank – inside a building where fumes may reach a spark, open flame, or any other source of ignition (such as a water heater, furnace, or clothes dryer). Allow the engine to cool before storing in any enclosure.
- Replace all fuel tank and container caps securely and wipe up spilled fuel. Never operate the unit without the fuel cap securely in place.

Safety Information

Vibrations (Where Applicable)

- Prolonged use of hand held (operated) machines will cause the user to feel the effects of/from vibrations. These vibrations can lead to white finger (Raynaud's phenomenon) or carpal tunnel syndrome. This condition reduces the ability of the hand to feel and regulate temperature, causing numbness and heat sensations and may cause nerve damage and circulatory tissue death.
- Not all factors that lead to white finger disease are known, but cold weather, smoking and other diseases that affect blood vessels and blood circulation, as well as large and long-lasting impact of shocks are considered factors in the formation of white finger. Note the following to reduce the risk of white finger and carpal tunnel syndrome;
- Wear gloves and keep your hands warm.
- Take regular breaks.
- All of the above precautions may help reduce the risk of white finger disease but not rule out the carpal tunnel syndrome. Long-term and regular users are therefore recommended to observe the condition of your hands and fingers. Seek medical attention immediately if any of the above symptoms should occur.

Noise (Where Applicable)

- The operating noise of the machine can damage your hearing. Wear the appropriate protection such as; earplugs or ear defenders to protect your hearing. Long-term and regular users are advised to have hearing checked regularly. Be especially vigilant and cautious when wearing ear protection because your ability to hear alarm warnings will be reduced.
- Noise emissions for this equipment is unavoidable. Carry out noisy work at approved times and for certain periods. Limit the working time to a minimum. For your own personal protection and protection of people working nearby it is also advisable for them to wear hearing protection.
-  See Certificate of Conformity section for Outdoor Noise declaration of conformity.

Safety Information

Intended Use

The HYMT5200X-1 is a petrol powered multi-tool from HYUNDAI and is powered by a 52cc 2-stroke petrol engine.

The multi-tool is manufactured according to the latest safety requirements. Every precaution is only effective when it is followed exactly.

Intended Use:

Hedge trimmer - This appliance is intended for the cutting and trimming of hedges, bushes and flowering shrubs in the home environment. This is a hand-help appliance with an integrated engine unit with linear reciprocating cutting blades.

Pole Saw - This appliance is intended for trimming branches in trees.

Brush cutter - This appliance is for cutting high grass, undergrowth and light scrub.

Grass trimmer - This appliance is for cutting grass and small weeds.

User Types

This machine is intended for use by consumers, i.e. non professional operators. The machine is intended for "DIY" and domestic use only.

Improper Use

Any other usage not in keeping with the above mentioned ones may be hazardous and could harm persons and/or damage objects. Due to the physical risk posed to the user, the appliance may not be used to perform the following activities: cleaning footpaths and as a shredder for shredding tree and hedge sections.

Furthermore, the appliance may not be used to level ground elevations such as molehills. For safety reasons, the appliance may not be used as a drive unit for any other devices. The user, not the manufacturer, is liable for any resulting damage or injuries of any kind.

Safety Information

Personal Protective Equipment

Appropriate Personal Protective Equipment (PPE), MUST be worn at all times when operating or repairing the machine. No protective equipment can ensure 100% protection.

When selecting PPE, make sure it's CE marked and it suits the user in terms of size, fit, etc. If more than one item of PPE is worn at the same time, make sure they can be used together, e.g. wearing safety glasses may disturb the seal of a respirator, causing air leaks.



Hand Protection Must Be Worn

Protective electrically non-conductive gloves are highly recommended when working.



Foot Protection Must Be Worn

Non-skid heavy duty footwear are highly recommended when working.



Hearing Protection Must Be Worn

Suitable safety hearing protection is recommended.



Eye Protection Must Be Worn

Always wear safety glasses/goggles and/or face shields. Everyday eyeglasses have only impact resistant lenses; they are not safety glasses/goggles.



Protective Clothing Must Be Worn

Do not wear loose clothing, gloves, scarfs, neckties or jewellery (rings, wrist watches), which can be caught in moving parts.



Head Protection Must Be Worn

Wear a safety helmet with a safety visor.

















Face Shield Must Be Worn

Wear a face shield to protect your face.

Safety Information

! Symbols On The Machine

We have provided safety messages in this manual and on the machine. This information alerts you to potential hazards that could hurt you or others. Please read these messages carefully. However, we may not have listed all of the possible hazards, you must also use your own judgement.

Symbol	Description	Symbol	Description
	WARNING You must read and understand all instructions before use.		WARNING Hot parts.
	WARNING Read the operating instructions before use.		SOUND Sound power level LWA data in dB.
	PPE Wear ear protection.		WARNING Fire, naked flames and smoking are prohibited
	PPE Wear protective goggles		IMPORTANT Add a little grease after every 20 hours of operation (gear grease).
	PPE Wear a hard hat.		CARBON MONOXIDE Never operate the engine indoor or in areas with low ventilation. The exhaust gas from the engine contains carbon monoxide
	PPE Wear safety shoes.		WARNING Do not use circular saw blades for the cutting blade function.
	PPE Wear protective gloves.		WARNING Fire, naked flames and smoking are prohibited.

Safety Information

! Symbols On The Machine



We have provided safety messages in this manual and on the machine. This information alerts you to potential hazards that could hurt you or others. Please read these messages carefully. However, we may not have listed all of the possible hazards, you must also use your own judgement.

Symbol	Description	Symbol	Description
	IMPORTANT Keep a safe distance away		PRIMER Press the primer bulb.
	WARNING Risk of injury due to running blades.		WARNING Falling objects, especially when cutting above head height
	WARNING Beware of flung objects.		WARNING Protect the appliance from rain and moisture
	IMPORTANT Left hand thread		CAUTION Risk of injury from rotating cutting blade. Keep hands and feet away.
	WARNING Beware of kickback		WARNING The cutting tool continues running after it is turned off (cutting blade/cutting filament)
	IMPORTANT A distance of 15m must be maintained between the machine and third parties.		CE & UKCA SYMBOLS This product complies with the applicable European & UK directives and an evaluation method of conformity for these directives was done.
	WARNING Risk of fatal electrical shock! Keep at least 10m away from overhead power lines		WARNING Petrol is highly flammable! Explosion hazard! Do not spill fuel!

Safety Information

! Symbols On The Machine

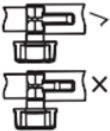
We have provided safety messages in this manual and on the machine. This information alerts you to potential hazards that could hurt you or others. Please read these messages carefully. However, we may not have listed all of the possible hazards, you must also use your own judgement.

Symbol	Description	Symbol	Description
	<p>IMPORTANT</p> <ol style="list-style-type: none">1. Push the pin on the front boom into the groove on the engine unit boom as far as the stop.2. Once it is correctly inserted, the red line must match up with the one on the engine unit boom.3. If this is not possible, pull on the starter pull cord to adjust the shaft. The On/Off switch must be set to "0".		<p>WARNING</p> <p>Turn the appliance off and disconnect the spark plug before performing any maintenance work.</p>

Unboxing

⚠ WARNING : Unboxing and assembling the machine should be done on a flat, surface with plenty of room. Disposal of the packaging should be done in accordance with the local regulations in force.

⚠ WARNING : Some of the packaging material may be harmful to children. **Keep out of reach of children.**

1. Carefully remove the product from the packaging and examine it for any sign of damage caused during shipping.
2. Lay the contents out and check them. If any part is damaged or missing, you must not use the machine. Contact HYUNDAI POWER PRODUCTS immediately.
3. You must keep the packaging material in case the machine needs to be returned or repaired.
4. Ensure that you have all the accessories and tools you need for assembly and operation, including the suitable personal protective equipment.

In The Box

*Not To Scale

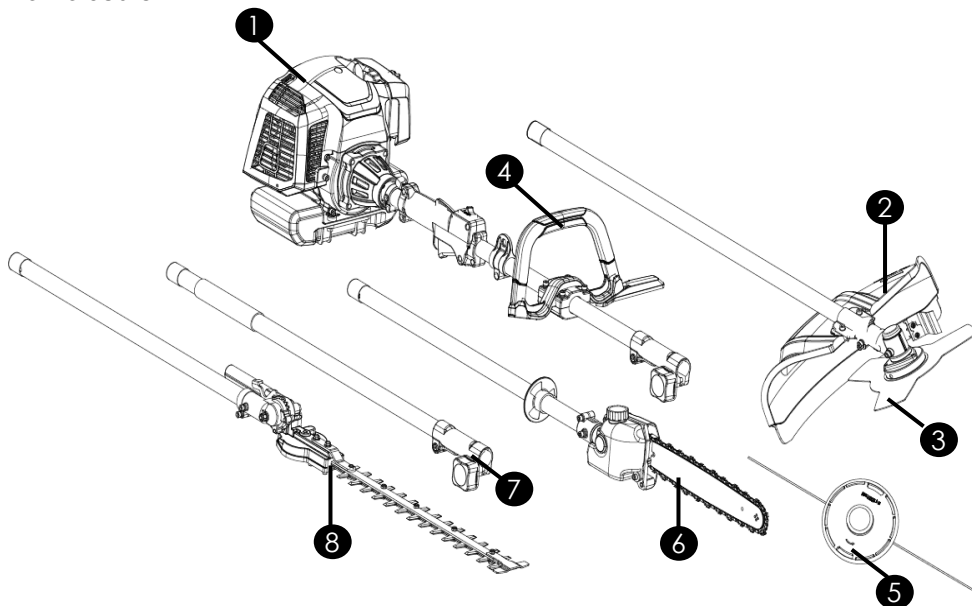

9

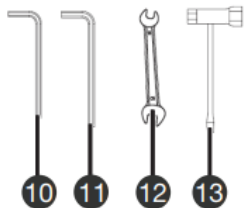

10

11

12

13



14



15



16



17

Descriptions on next page 

Features

- 1 **Engine**
- 2 **Guard**
- 3 **Brush Cutter 3 Tooth Blade**

The brush cutter will allow you to cut through thicker and tougher foliage.
- 4 **Handle**
- 5 **Grass Trimmer Head**

The Grass trimmer will enable a quick and efficient cut through overgrown grass, and to trim the edges of your lawn.
- 6 **Pole Saw**

The 295mm cutting bar is suitable for all but the biggest of logs and branches.
- 7 **Extension Shaft**

The quick-release extension shaft provides approximately 800mm of extra reach (allowing you to reach up to 4m in total).
- 8 **Hedge Trimmer**

With a blade length of 425mm, the hedge trimmer is built to prune large hedges with ease.
- 9 **Tool Kit**
- 10 **Hex Key 4mm**
- 11 **Hex Key 5mm**
- 12 **8mm/10mm Spanner**
- 13 **Spark Plug Box Spanner/Screwdriver**
- 14 **Harness**
- 15 **Hedge Trimmer Protector**
- 16 **Pole Saw Protector**
- 17 **Mixing Bottle**

Assembly

Assembly Overview

There are 6 steps to the assembly:

STEP 1. Attach The Engine Unit Handle

STEP 2. Cutting Blade Attachment

STEP 3. Lower Guard Assembly

STEP 4. Grass Trimmer Head Assembly

STEP 5. Pole Saw Attachment Assembly

STEP 6. Using The Harness

STEP 1 : Attach Engine Unit Handle

1. Fit the lower handle onto the unit (with 4mm Hex key). The lower handle will fit around the shaft.
2. Loosen and remove the screws located in the lower handle moulding. This will separate the moulding.
3. Once the moulding is separated, open the rubber bush, fit the bush around the shaft and locate the pin into the chosen hole. You can choose to insert the pin to either the upper, or lower hole located on the shaft (depending on user height).

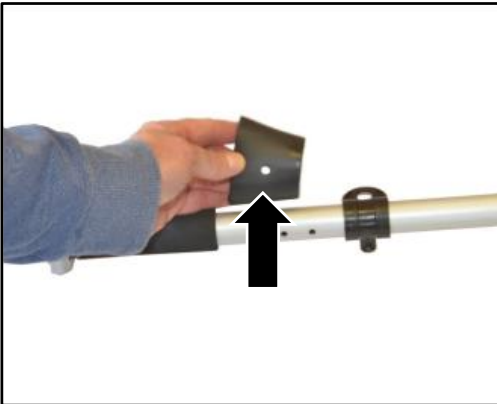

Fit the moulding around the shaft.

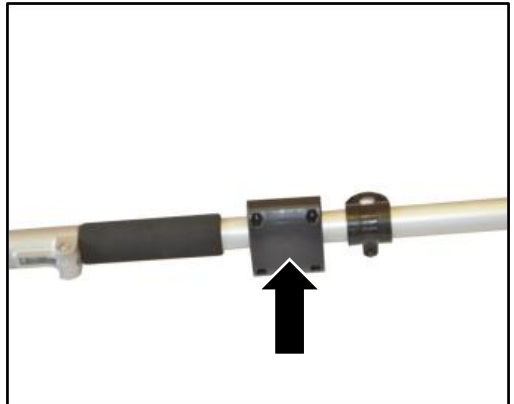

Moulding fitted and pin secured.

Assembly

STEP 1 : Attach Engine Unit Handle (Continued)

4. Place and secure the handle onto the moulding. The handle **MUST** be facing inwards towards the engine unit.
5. Attach both halves of the moulding back together and tighten the bolts to secure the handle.

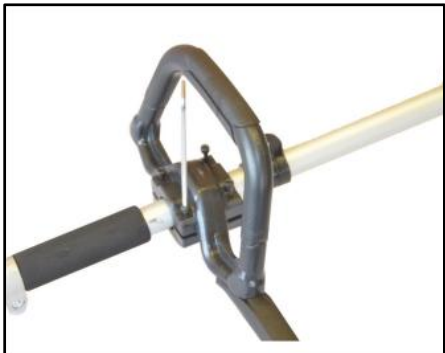

The picture (left) depicts correct assembly of the lower handle.

STEP 2 : Cutting Blade Attachment

1. Remove the assembly head by inserting the 5mm Hex key through the hole located to the side of the outer pressed steel ring and loosen the central nut by unscrewing clockwise. Use the box spanner to unscrew the central nut.

NOTE - Ensure the outer ring hole and inner drive coupling ring are aligned when inserting the 5mm Hex key. This will enable the head to lock into place.

NOTE - Left-hand thread means the central nut will need to be loosened in a clockwise direction and anti-clockwise to tighten.

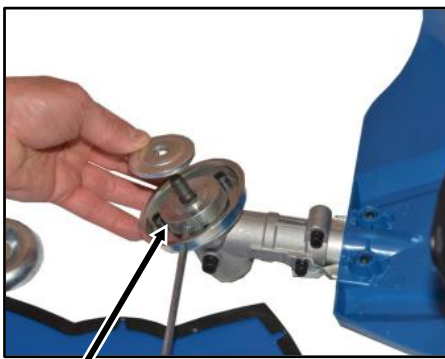

2. Once the nut is free, remove the plate and upper washer. Keep the drive coupling in place.

NOTE – Be sure to keep the components safe to one side.

Keep the drive coupling in place to attach the cutting blade. As shown above

Assembly

STEP 2 : Cutting Blade Attachment (Continued)

3. Fit the Cutting blade by placing the blade face down over the central register. The Hyundai marking on the blade should be out of sight and facing towards the head.

⚠ IMPORTANT!: Ensure the blade sits flush on the head. Extreme vibration will occur if it is not mounted correctly.

4. Place the upper washer over the blade with the 'dome side' facing up. Next, place the 'doughnut' ring over the washer and fasten the nut firmly anti-clockwise.

NOTE: Place the 5mm Hex key into the locking hole and lock the head into place, then continue to tighten the nut anti-clockwise until firmly secure.

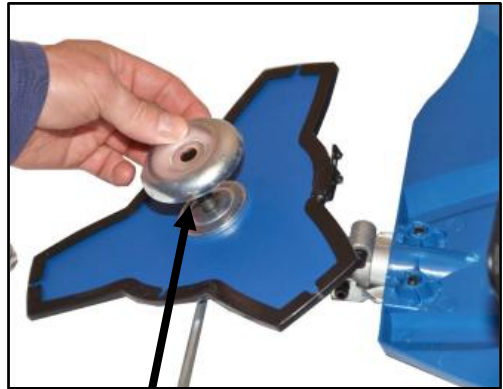
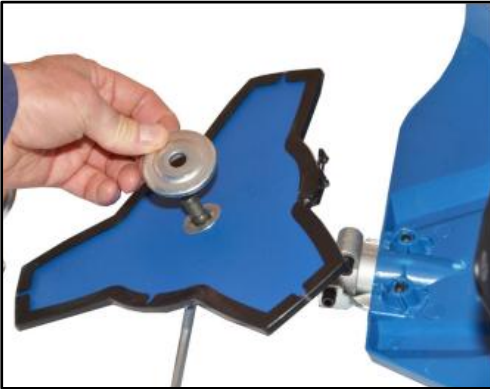

For correct fixture, ensure the upper washer is placed 'dome side' up.

⚠ IMPORTANT: Once the Cutting blade is secure, spin the blade to ensure it is firmly secured. Incorrect mounting will cause extreme vibration.

Assembly

STEP 3 : Lower Guard Assembly

1. Remove the two bolts that are already in place in the guard.



2. Line up the guard to the holes located on the bracket, in readiness to fasten the bolts.

Use the 5mm Allen key to tighten the bolts and secure the guard.

STEP 4: Grass Trimmer Head Assembly

1. Ensure the drive coupler remains secured in the assembly head.
2. Use the 5mm Hex key to lock the drive coupler in place.
3. Fit the grass trimmer head by screwing it on anti-clockwise, while keeping the drive coupler locked with the 5mm Hex key.

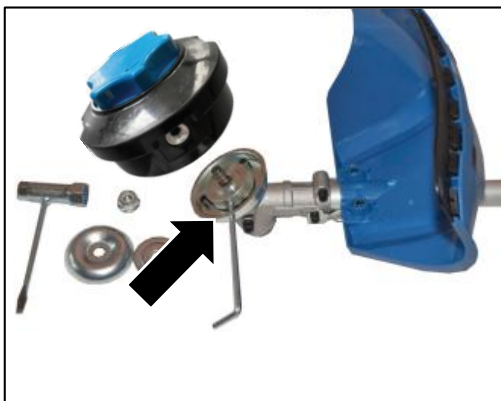

NOTE: Drive coupler must remain in place to fit the trimmer head. Use the 5mm Hex key to lock into place.



NOTE: Left-hand thread. Turn anti-clockwise to fasten the trimmer head.

Assembly

STEP 5 : Pole Saw Attachment Assembly

! WARNING: The teeth on the chain are very sharp. It is strongly advised that thick gloves are worn when handling the chain.

1. Remove the two bolts that are already in place in the guard.
2. Fit the chain around the sprocket. **Above the chain links, ensure the small tooth is on the left and the large tooth is on the right.** This indicates the chain has been placed in the correct orientation.

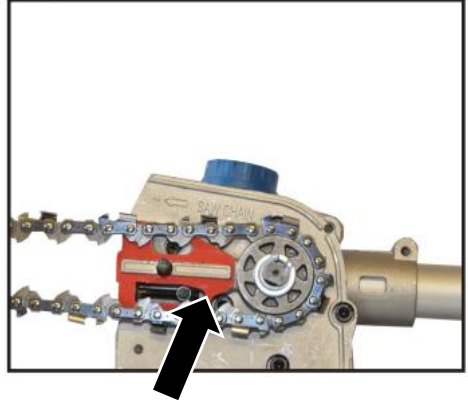

The picture above illustrates the small tooth on the left, and the large tooth on the right. This is the correct orientation.

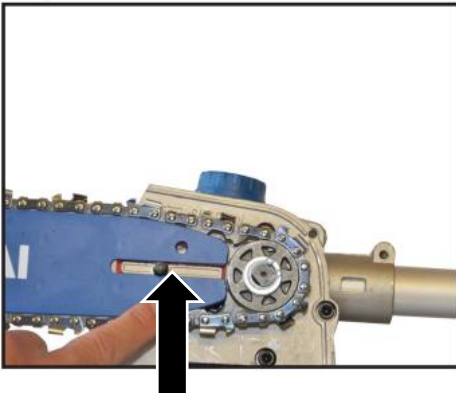

3. Attach the bar to the chain. Begin by placing the nose of the bar into the end of chain (left-side) before moving the opposite end of the bar over the pin to the left-hand-side of the sprocket.

The pin will slot into the gap of the chain bar..

Assembly

STEP 5 : Pole Saw Attachment Assembly (Continued)

4. Continue to secure the bar to the chain by feeding teeth around the circumference of the bar until correctly positioned.
5. Refit the bar cover back into position and secure the nut onto the thread. **DO NOT** fully tighten the bar cover nut until the chain has been correctly tensioned.
6. Adjust the chain tension by using the flat-headed screwdriver adjoined to the Spark Plug Box Spanner. Tighten the screw, located above bar, clockwise half a turn at-a-time until the chain is tensioned correctly (See top-left picture below).

⚠ IMPORTANT: DO NOT over tighten the chain. Using gloves, check the tension of the chain by pulling the chain around the bar. If correctly tensioned, you should be able to pull the chain about 5mm away from the bar.



Adjust the chain tension by turning the screw with the flat-



Keep checking the chain's tension until suitably firm. Multiple adjustments may be necessary until secure.



7. Firmly tighten the nut to secure the bar cover.

Assembly

STEP 5 : Pole Saw Attachment Assembly (Continued)

! **IMPORTANT:** During the Pole saw attachment's initial use, the chain's tension may slacken. Check the chain periodically to ensure the tension is at its optimum. Adjust accordingly if the chain has lost its tension.

! **NOTE:** Before use, fill the reservoir with chain lubricating oil. We recommend you put environmentally friendly, organic chain oil in the oil tank before using this attachment. **DO NOT** use old engine oil.

STEP 6: Using the Harness

1. Attach harness using quick release mechanism.
2. The black clamp can be loosened with 4mm Hex key and adjusted back and forth to get the required balance of the machine.
3. The white buckle goes to the front of your body.

! **IMPORTANT:** Always use the harness when working with the machine. Turn the engine off before removing the harness.



Preparation – Before Each Use

 **YOU MUST read and understand the full safety instruction manual before starting the machine.**

 **CAUTION** – For OUTDOOR use ONLY. Petrol machines produce monoxide – poisonous, colourless and odourless gas that can cause serious injury or death. Petrol is highly flammable, always handle with extreme care and in a well ventilated area.

1. Always ensure that the machine is in a safe working condition. Inspect and check safety devices and guards and check all nuts, bolts and screws are secure
2. Check the oil level and fill the fuel tank.
3. Make sure you know how to stop the machine and ensure you are familiar with emergency stop.
4. Start the machine following the instructions and stay clear of the machine's moving parts.

Preparation – Fuel And Oil

IMPORTANT: This is a 2-stroke engine and will need 2 stroke oil mixed with the unleaded petrol.

The mix is 40 parts petrol to 1 part oil. (40:1). i.e. 1 litre of petrol requires 25ml of (semi-synthetic) 2 stroke oil.



CAUTION - Petrol is extremely flammable and must be mixed away from any naked flame or cigarette. Mixing petrol and oil must be done in a well ventilated area, preferably outside. Make sure you read the fuel safety before handling fuel.

1. Add the respective correct amounts of unleaded petrol and 2-stroke oil to the supplied oil/petrol mixing canister then shake the canister well.
2. Fill the petrol tank with fuel. Do not fill to the top of tank. Leave at least 50mm from the top of cap.



CAUTION: Do not fill above the illustrated line in case of spillage.

! IMPORTANT: Always re-fuel with fresh fuel when possible. Stale fuel can damage the engine and associated fuel lines.

Fuel Safety

! CAUTION: Never remove the tank filler cap or top up the petrol tank while the engine is running or hot. Allow time for the engine and the exhaust components to cool down before refuelling.

For your safety, please refer to the following:

- Do not smoke when handling fuel and/or in an environment where fuel is present.
- Refuel outside only
- Never store the hedge trimmer or the fuel tank in a room where there is an open flame. For example, in a hot water boiler.
- If the petrol has overflowed, do not attempt to start the engine. Remove the appliance from the fuel-contaminated area before restarting. Clear the contaminated area.
- Always replace the filler cap after refuelling and close it securely.
- Draining the tank should only be done in the open.
- To minimise the risk of fire, ensure that the engine and the silencer are free of residues, leaves or leaked lubricant.

Operation

Connecting The Extension Boom

1. Remove the rubber cap from the end of the shaft.
2. Insert the boom into the end of the engine unit shaft. Ensure the rectangular slot with the square plastic piece is facing the bottom when inserting the boom into the end of the shaft. The circular part will be on the top of the boom.
3. Slide the boom upwards to the red-line marked at the end of the shaft.
4. Firmly tighten the blue hand screw so the boom is secure with no side-wards movement.

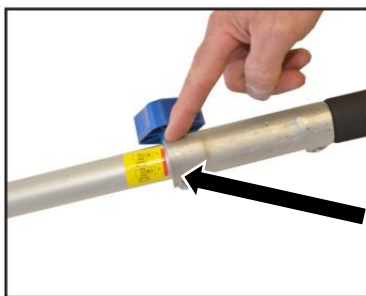

The extension boom **MUST** be inserted to the red-line indicated.

Using The Extension Boom



1. The extension boom is attached between the motor unit and the tool being used to increase the height you can reach. Use the extra hand grips on the extension boom.
2. **⚠ CAUTION:** Be aware of overhead power/telephone wires.
3. Do not put undue pressure on the tool when using extension boom.
4. **⚠ CAUTION: DO NOT** use extension boom with the trimmer/blade attachment.

Operation

Using The Grass Trimmer

1. To extend trimmer line from head, with the head spinning, simply bump the head down onto the ground and the line will automatically be fed out from the spool inside the head.
2. Do not press trimmer head hard onto the ground when using the trimmer. This will prematurely wear out the head.
3. Always use the harness as shown.
4. Always use both hands to hold the machine.
5. Always wear eye and ear protection.
6. Be aware of your surroundings.
7. **DO NOT** use near children and pets



NOTE: Maintain a sensible distance between the ground and grass trimmer head. Excessive pressure on the head can lead to damage of the device.

Operation

Using The Pole Saw

! CAUTION: Use extreme care whilst using this attachment. NEVER operate around children and pets.

! CAUTION: Be aware of overhead power/telephone wires.

1. Always check the tension of the cutting chain before use.
2. This tool is only for pruning trees. Do not cut wood lying on the ground.
3. Hold the saw firmly with two hands and make sure your footing is secure.
4. Saw down onto the branch. Avoid sawing upwards beneath the branch. Sawing beneath the branch can cause the blade to become trapped when the branch starts to fall.

! CAUTION: BE AWARE OF FALLING BRANCHES



Using The Pole Saw – Preventing Kickback

1. Kickback happens when the tip of the blade catches in the wood you are cutting. This causes the blade to jerk and you may lose control. NEVER cut using the top part of the tip of the blade.
2. Do not apply too much pressure on the tool.
3. Always place the protective guard over the blade when you are finished.
4. Avoid any abnormal posture. Do not raise your hands above shoulder height when operating the saw. This will prevent inadvertent contact with the tip of the rail, and allows for better control with the chainsaw in unexpected situations.
5. Always use replacement rails and saw chains specified by the manufacturer. Incorrect replacement rails and saw chains can lead to the saw chain tearing and/or kickback.
6. Do not saw with the tip of the blade. This can lead to kickback.
7. Ensure there are no objects on the ground that you can trip over.
8. When operating the saw, hold the handle firmly with both hands. Place your thumb and fingers around the around handle. Position your body and arms so you can withstand kickback forces. If suitable measures are taken, the operator can control the recoil forces. NEVER let go of the chainsaw.
9. Do not rely solely on the chainsaw's built-in safety devices. As the user of the chainsaw, you can take a number of measures to avoid accidents and injury. A kickback is caused by incorrect use or misuse. **It can be avoided by following the above safety measures and taking proper precautions.**

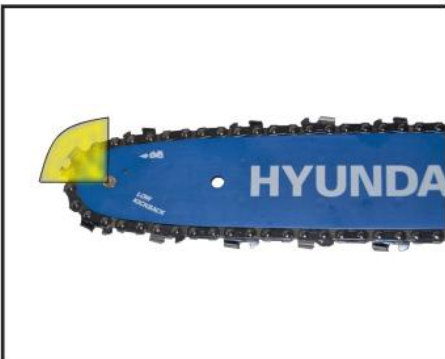

IMPORTANT: To prevent the chance of kickback, avoid cutting wood within the highlighted area.

Operation

Using The Cutting Blade

! CAUTION: Use extreme care when using this tool.

1. Always firmly grip the handle with both hands when using the cutting blade attachment.
2. Keep children and pets at least 15m away when using.
3. The blade can fling stones and debris with great force. Always use face, leg and ear protection.
4. The blade can kickback violently if it comes into contact with hard objects.
5. The blade will keep spinning after the throttle has been released. Make sure the blade has stopped spinning before letting go of the machine.



! IMPORTANT: Prior to use, ALWAYS check the blade is firmly secured. Spin the blade to ensure it is firmly secured. Incorrect mounting will cause extreme vibration.

Using The Hedge Trimmer

⚠ CAUTION: Use extreme care whilst operating this attachment.
Avoid operating around children and pets.

1. Always use eye and ear protection.
2. Always switch off the engine before performing any maintenance or adjustments to the cutting blades.
3. You can adjust the angle of the cutting blades by squeezing together the two levers near the joint. See image below:



Squeeze the two levers together to adjust angle of cutting blades.

4. Be careful of any fencing wire within your hedge.
5. The double-sided cutter bar allows cutting in both directions or by using swinging movements from one side to the other.
6. For a vertical cut, move the hedge trimmer evenly forwards, or up and down in an arc.
7. For a horizontal cut, move the hedge trimmer in a scything motion along the edge of the hedge so the cut branches fall to the ground.

Operation

Re-Filling The Trimmer Line

NOTE! This machine requires 2.4mm thick Nylon Trimmer Line

1. Rotate the blue centre piece to align the arrow mark with the holes.
2. Check that the two holes are aligned.



3. Using 4m of 2.4mm nylon trimmer line, pass it through the two holes until you have 2m each side.

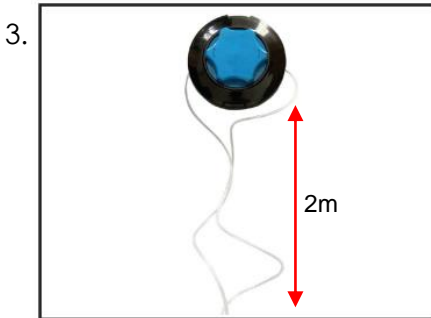

4. Turn the blue centre piece clockwise until there is 20cm of line remaining.



Starting/Stopping Procedure

⚠ NOTE: This machine is shipped without fuel and oil and **MUST** be filled before use. Failure to do so may cause damage to the engine that will not be covered by warranty.

Cold Start

1. Squeeze the primer bulb at least 6 times until fuel is being moved through the fuel line.
2. Switch the ignition on by sliding the On/off switch backwards toward the engine.



The fuel mixture will be present in the primer bulb once sufficiently primed.

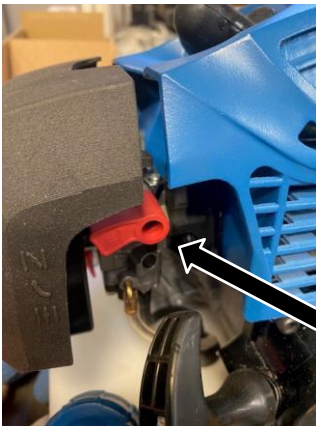

3. Turn the choke lever to the left side.

For a cold start, move the choke lever to the left position.

Starting/Stopping Procedure

Cold Start (Continued)

4. With your left hand holding down the engine, firmly pull the start cord with your right hand. Repeat until the engine starts, or attempts to start.

5. Once the engine starts, gently squeeze the throttle to disengage the choke. The choke will automatically disengage and return to the right (off) position once the throttle has been squeezed.

4.



5.



Choke disengaged and positioned to the right.

To operate the throttle, press down the throttle lock-out lever. Once the throttle lock-out lever is engaged, gently apply pressure to the throttle trigger.

- **Once the engine starts following a successful cold start, please proceed to Step 6.**

- **If the engine attempts to start but fails to do so, disengage the choke by gently squeezing the throttle and restart the cold-start process.**

NOTE: When performing a cold start, take care when applying the choke. If the engine attempts to turnover with the choke engaged, squeeze the throttle to disengage the choke.

⚠ Excessive attempts to start the engine with the choke engaged can flood and damage the engine.

6. Continue to squeeze throttle to gradually increase the revs for operating the machine.



Starting/Stopping Procedure

Warm Start – when the appliance has been turned off for less than 10 minutes. Start the machine with the choke in the down position.

1. Slide the On/Off switch back towards the engine. Place left hand on top of engine.
2. Pull the cord to restart the engine.

⚠ CAUTION: Engine may be hot! Pull the starter cord until engine starts.



Stopping The Engine

⚠ CAUTION: The engine and exhaust will remain hot for a while after use. Ensure the engine and exhaust has cooled before carrying out any maintenance, refuelling or storage.

NOTE: It is advised that you release the throttle and leave the engine run idle for around 15 seconds before switching the ignition off and stopping the engine.

1. Release the throttle, leave idle for around 15 seconds and slide the On/Off switch back forwards, away from the engine.





Maintenance

Maintenance Safety

 **IMPORTANT** - Routine and accurate maintenance is essential for maintaining original machine safety and performance levels.

 **WARNING** - Before cleaning or doing maintenance work, you need to stop the engine, disconnect the spark plug cable and read the relevant instructions. You need to wear proper clothing and protective gloves whenever your hands are at risk.

 If there are worn or damaged parts, never use the machine. Faulty or worn-out parts must be replaced and not repaired. You must only use original spare parts. The use of non-original and/or incorrectly fitted parts will jeopardize the safety of the machine. This may also cause accidents or personal injuries for which the manufacturer is under no circumstance liable or responsible.

 Any maintenance operations or adjustments not explained in this manual must be carried out by your Dealer or a specialised Service Centre with the necessary knowledge and equipment to ensure that the work is done correctly to maintain the machine's original safety level. Any operations performed in unauthorised centres or by unqualified persons will invalidate the Warranty and all obligations and responsibilities of the Manufacturer.

 Be very careful during adjustment of the machine to prevent entrapment of the fingers between moving parts and fixed parts of the machine.

Checking Your Machine

When checking your machine, we recommend you:

- Check for worn or damaged parts.
- Make sure all nuts, screws and bolts are tight and secure.
- Make sure all warning stickers are in place and not damaged.
- Check for oil / fuel leaks.
- Check the oil and fuel levels regularly.
- All moving parts can move smoothly and freely.

Maintenance

Cleaning

⚠ CAUTION – DO NOT use a hose pipe or pressure washer to clean the engine. Water can damage the engine and/or contaminate the fuel system.

NOTE – Engine must be switched off and spark plug lead disconnected.

General Cleaning

- You must remove grass and mud from the machine to prevent it from drying. This will cause problems the next time the machine is used.
- Wipe the machine down with a damp cloth.
- For larger build ups of debris, use a scraper or similar product.
- Dry the machine completely to prevent rust from forming.
- Make sure not to drip petrol onto the plastic parts to prevent damaging them and remove all traces of spilt petrol immediately. The warranty will not cover damage to plastic parts caused by petrol.
- Avoid using solvents when cleaning plastic parts. Most plastics are susceptible to damage from various types of commercial solvents and may be damaged by their use.

Cleaning The Pole Saw

NOTE – The pole saw must be cleaned of sawdust at regular intervals.







- Remove the sprocket cover
- Remove the saw chain from the blade and clean the guide rail.
- Dry the machine completely to prevent rust from forming
- Keep the saw chain sharp and check the tension; check the oil level and the oil supply.

Cleaning The Hedge Trimmer

- Check the hedge trimmer for loose screws on the cutter bar and tighten them if necessary.
- Remove stuck cuttings.
- Maintain the cutter bar using an oil spray or an oil can.

Maintenance

Storage – Where To Store

-  Store in a cool, dry place away from sources of ignition and varying changes in temperature.
-  **DO NOT** stack other items on top of the machine when in storage. The protectors must be fitted for transport and storage.
-  Store the machine in a safe place, out of the reach of children or anyone who is not familiar with operation.
-  To reduce fire hazards, keep the engine, silencer, and petrol storage area free of grass, leaves, or excessive grease. Do not leave containers full of cut grass inside storage areas.
-  **DO NOT** store the machine with fuel in the tank in an area where the fuel vapours could reach an open flame, a strong heat source or a spark.
-  **DO NOT** store a machine that has not been given time to fully cool down. Engine must be cooled down fully before storage.

Short Term Storage

After use, please follow the below steps before storing your machine.

1. Allow the engine to fully cool down.
2. Clean the machine. See the 'Cleaning' section.
3. Store the machine following the guidelines above.

Long Term Storage

If storing the machine for a period of 30 days or more, you must follow proper storage and winterisation guidelines to avoid any possible issues with the machine. Incorrect storage can lead to possible fueling or engine issues that will not be covered by the warranty.

1. Allow the engine to fully cool down.
2. Drain all the fuel from the fuel tank and then run the machine until it has completely run out of fuel to clear the remaining fuel from the fuel lines and carburettor.
3. Follow the cleaning instructions in the 'Cleaning' section.

Maintenance

Long Term Storage (Continued)

4. Follow the maintenance section and check, service or replace serviceable items if required. Visually inspect the machine and replace or repair any worn parts. Check the blade and sharpen or replace if necessary.
5. Remove the spark plug. Add 1 teaspoon of 2-stroke oil to the combustion chamber. Pull the starter pull cord several times to wet all mechanical parts with oil. Replace the spark plug.

Preparation To Re-Use

1. Remove the spark plug.
2. Pull the starter pull cord quickly in order to remove any excess oil from the combustion chamber.
3. Clean the spark plug and observe the correct electrode gap on the spark plug.
4. Fill the tank.

Transportation

Whenever the machine is to be handled, lifted, transported or titled, you must:

1. Wear sturdy work gloves.
2. Hold the machine at the points that offer a safe grip. Take the machine's weight in certain areas to account when handling and lifting.
3. Use an appropriate number of people for the weight of the machine and consider the characteristics of the vehicle or the place where it must be placed or collected.
4. You must make sure that machine movements do not cause petrol leaks, damage or injuries.
5. During transport, make sure to fasten the machine securely with cables or straps.
6. Always use the protective cases and ensure that the machine cannot switch on during transport. Always carry the machine with the sharp parts facing away from your body.

Maintenance

Pole Saw Oil

1. You can adjust the amount of oil that is applied to the chain by turning the screw located underneath the chain guard cover. It has 3 positions. The middle is the factory set position. Push and click anticlockwise for more oil. Push and click clockwise for less oil.
2. Check the oiling system is working by holding and running the saw blade close to a surface. Oil will be flung off the chain and on to the surface if it is working properly.

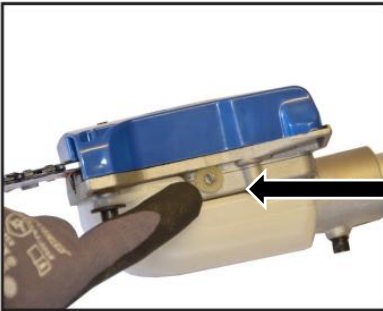

Adjust the oil output by turning the screw accordingly.

Pole Saw Chain Sharpening

1. You can sharpen the chain by using the correct tool available at most garden machinery shops. The round file size is 3/8". Please follow the instructions that come with the tool.



Maintenance

Air Filter

⚠ CAUTION - A dirty air filter will restrict the air flow to the carburettor, which will reduce engine performance and efficiency.

⚠ This machine uses an Oil Soaked foam air filter. This type of filter can be removed and cleaned. If cleaned always remember to re-soak the air filter in oil.

When using the machine in very dusty areas you must clean or replace the air filter more often. Never operate the machine without the air filter being fitted. Improper use can cause damage to the engine which is not covered by warranty.

1. Regular inspection is essential. The air filter must be inspected after every 25 hours of operation, and cleaned if necessary.
2. Remove the cover of the air filter housing.
3. Remove the air filter.
4. Clean the air filter by tapping or blowing it out.
5. Assembly is done in the reverse order.

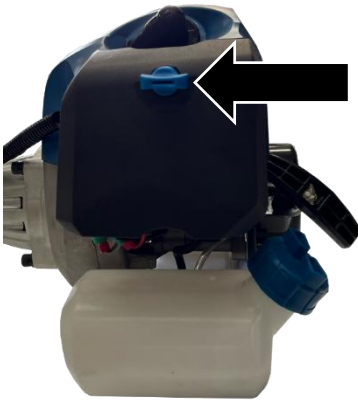

Loosen the handnut and open the air filter cover.



Once the air filter is open, remove the filter to clean and replace when finished.

Maintenance

Spark Plug

For good performance, the spark plug must be properly gapped and free of deposits.

1. You **MUST** allow the engine to cool down before carrying out any maintenance.
2. Always use the correct spark plug.
3. Pull off the spark plug connector.
4. Remove the spark plug using the enclosed spark plug spanner.
5. Assembly is done in the reverse order.

Electrode gap = 0.6 mm (distance between the electrodes between which the ignition spark is generated). Check the spark plug for contamination after the first 10 hours of operation and clean it with a copper wire brush if required. Afterwards, service the spark plug after every 50 hours of operation.



Pull off the spark plug cover (as pictured) and remove the spark plug by using the spark plug box spanner provided. Unscrew anti-clockwise to remove.

Lubricating The Gears

1. Add liquid gear grease after every 20 hours of operation (approx. 10g) to lubricate the angle gear.
2. To do this, undo the screw to press the gear grease into the gear housing.
3. After filling the gearbox, close the lubrication hole with the screw.



Maintenance

Lubricating The Saw Chain

1. Remove the oil filler cap.
2. Fill oil tank with organic chain oil.
3. The chain lubrication can be increased or decreased using the oil adjusting screw.
4. Press and then turn the oil adjusting screw clockwise to decrease the chain lubrication.
5. Press and then turn the oil adjusting screw anticlockwise to increase the chain lubrication.

⚠ WARNING - Never work without lubricating the chain first. If the saw chain runs dry, the cutting equipment may become damaged within a short time. **Always check chain lubrication before starting work.**

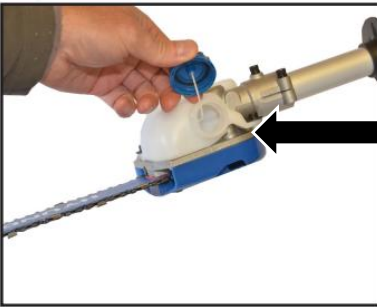

Fill oil tank with organic chain oil.

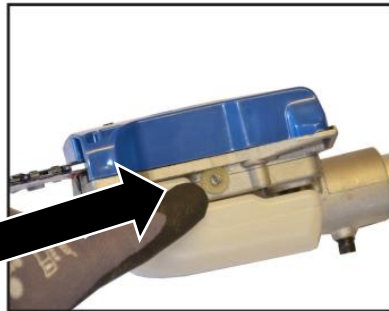

Turn screw anti-clockwise to decrease chain lubrication, or turn clockwise to increase.

Maintenance

Tightening And Checking The Saw Chain

⚠ WARNING – Wear protective gloves. There is a danger of injury from the sharp cutting teeth. A new saw chain stretches and must be tightened more frequently.

1. First loosen the cover retaining nut to release the bar.
2. Turn the chain-tensioner screw in a clockwise direction using the flat-blade screwdriver to increase the tension.
3. The saw chain must lie against the underside of the blade. Check whether the saw chain can be drawn over the blade by hand.

NOTE: A new saw chain stretches and must be tightened more frequently.



Maintenance

The figures given here are based on normal operating conditions. In the event of more difficult conditions, such as strong dust generation and longer daily operating hours, the given intervals are to be reduced accordingly.

Pole Saw Maintenance Schedule

Appliance Part	Before Starting Work	Weekly	In The Event of Faults	In The Event of Damage	As Required
Lubricating The Chain	Check				
Check Saw Chain	1. Check The Sharpness 2. Check Chain Tension				Sharpen
Check Guide Rail	1. Check for wear/damage	1. Clean and turn. 2. Deburr	Clean and turn	Replace	Replace
Check Sprocket		Replace			Replace

Hedge Trimmer Maintenance Schedule

Appliance Part	Before Starting Work	After Completion Of Work	As Required
Cutting blade	Visual inspection	Cleaning	Cleaning

 Where necessary, all corrective actions should be carried out by a suitably qualified person.

Troubleshooting

Engine Unit Troubleshooting

Problem	Possible Cause	Possible Solution
The engine does not start.	Incorrect start-up process.	Follow the start procedure.
The engine starts but does not run at full power.	<ol style="list-style-type: none">1. Incorrect adjustment of the choke lever.2. Contaminated air filter.	<ol style="list-style-type: none">1. Move the choke lever to the upper position.2. Clean air filter.
The engine does not run smoothly.	Incorrect spark plug cap.	Clean the spark plug and adjust the spark plug gap, or replace the spark plug.
Soot deposits or wetness on the spark plug.	Incorrect carburettor adjustment.	Contact your service dealer.

Pole Saw Troubleshooting

Problem	Possible Cause	Possible Solution
Motor is running, saw chain does not move.	Pole saw attachment is not connected properly to the engine unit.	Check assembly.
Saw chain running slowly.	<ol style="list-style-type: none">1. Saw chain dry/overheating2. Saw chain is slack.	<ol style="list-style-type: none">1. Top up the oil, sharpen chain or replace.

Hedge Trimmer Troubleshooting

Problem	Possible Cause	Possible Solution
Motor is running, blades do not move.	Hedge trimmer attachment is not connected properly to the engine unit.	Check assembly.

Technical Data

Engine Specifications

Engine Type	2-Stroke Engine, Air-Cooled
Engine Output (Max)	1.45kW / 2.0hp
Engine Size	51.7cc
Engine Idle Speed	3000 ± 200rpm
Engine Speed (Max.)	With 3-Section Cutting Blade: 6900rpm With Grass Trimmer: 8700rpm With Chainsaw: 9200rpm With Hedge Trimmer: 1550rpm
Max. Cutting Speed	With 3-Section Cutting Blade: 6900rpm With Grass Trimmer: 6525rpm With Chainsaw: 20m/s With Hedge Trimmer: 1550 strokes p/m
Ignition	Electronic
Drive	Centrifugal Clutch
Weight (Power Unit with Empty Tank)	Approx. 5.6kg
Fuel Tank Capacity	1200cm ³
Spark Plug	CDK L8RTC
Fuel Consumption At Max. Engine Performance	0.6kg/h
Specific Fuel Consumption At Max. Engine Performance	446g/kWh

Engine Specifications

Oil Tank Recommended Fill Level	140cm ³
Cut Length	Approx. 260mm
Blade	10 inch
Saw Chain	10 inch

Technical Data

Engine Specifications

Engine Type	2-Stroke Engine, Air-Cooled
Engine Output (Max)	1.45kW / 2.0hp
Engine Size	51.7cc
Engine Idle Speed	3000 ± 200rpm
Engine Speed (Max.)	With 3-Section Cutting Blade: 6900rpm With Grass Trimmer: 8700rpm With Chainsaw: 9200rpm With Hedge Trimmer: 1550rpm
Max. Cutting Speed	With 3-Section Cutting Blade: 6900rpm With Grass Trimmer: 6525rpm With Chainsaw: 20m/s With Hedge Trimmer: 1550 strokes p/m
Ignition	Electronic
Drive	Centrifugal Clutch
Weight (Power Unit with Empty Tank)	Approx. 5.6kg
Fuel Tank Capacity	1200cm ³
Spark Plug	CDK L8RTC
Fuel Consumption At Max. Engine Performance	0.6kg/h
Specific Fuel Consumption At Max. Engine Performance	446g/kWh

Hedge Trimmer Specifications

Cut Length	410mm
Tooth Spacing	20mm

Technical Data

Pole Saw Specifications

Oil Tank Recommended Fill Level	140cm ³
Cut Length	Approx. 260mm
Blade	10 inch
Saw Chain	10 inch

Brush Cutter Specifications

Metal Blade Cutting Diameter	255mm
------------------------------	-------

Grass Trimmer Specifications

Nylon Line Cutting Circle	430mm
Nylon Line Length	4m
Nylon Line Diameter	2.4mm

Technical Data

Noise Information

	Hedge Trimmer	Pole Saw	Brush Cutter	Grass Trimmer
Sound Pressure Level LpA	99.47dB(A)	99.5	93.24	94.74
Uncertainty KWA	2.5dB	2.5	2.5	2.5
Sound Power Level LWA	110.05dB(A)	111.54	105.52	105.62
Guaranteed Sound Power Level LWA	114dB(A)	115	109	109
Uncertainty KWA	2.5dB	2.5	2.5	2.5

Vibration Information

	Hedge Trimmer	Pole Saw	Brush Cutter	Grass Trimmer
Vibration On Front Handle	Vibration Emission Value $a = 5.165\text{m/s}^2$ Uncertainty K = 1.5m/s^2	Vibration Emission Value $a = 7.41\text{m/s}^2$ Uncertainty K = 1.5m/s^2	Vibration Emission Value $a = 7.6\text{m/s}^2$ Uncertainty K = 1.5m/s^2	Vibration Emission Value $a = 7.09\text{m/s}^2$ Uncertainty K = 1.5m/s^2
Vibration On Rear Handle	Vibration Emission Value $a = 8.95\text{m/s}^2$ Uncertainty K = 1.5m/s^2	Vibration Emission Value $a = 7.993\text{m/s}^2$ Uncertainty K = 1.5m/s^2	Vibration Emission Value $a = 9.79\text{m/s}^2$ Uncertainty K = 1.5m/s^2	Vibration Emission Value $a = 12.85\text{m/s}^2$ Uncertainty K = 1.5m/s^2

Recycling & Disposal

Recycling & Disposal

We do not offer a takeback scheme for the recovery of Waste Electrical Electronic Equipment (WEEE) & Batteries. Instead the responsibility to dispose of WEEE and/or Batteries is passed onto you by us.

So when it becomes necessary to dispose of your machine you must take it to your local Civic Amenity Site. For further information please contact your local Authority for disposal advice.

You **MUST** make sure that all unused oil and fuel is disposed of correctly either beforehand or at your local Civic Amenity Site.

- Under NO circumstances must any fuel or oil be put down any drains.
- Certain products contain WEEE waste which should not be disposed of in your domestic waste.
- You **MUST** recycle WEEE in accordance with your local authority or recycling centre.
- Certain products contain batteries which should not be disposed of in your domestic waste.
- You **MUST** recycle batteries in accordance with your local authority or recycling centre.
- Unwanted packaging and materials should be stored and taken to a recycling centre so it can be disposed of in a manner which is compatible with the environment.

We are a Member of the VALPAK National Compliance Scheme and our registration number is RM08660. For further information about disposal please contact your Local Authority.

You can also get more advice and guidance about recycling at the following website <http://www.recycle-more.co.uk>

Should you pass this product on to another user either sold or loaned, you **MUST** pass on this user manual. This will make sure that all other users can use and maintain this machine safely.

Environmental Protection

1. Environmental protection should be a priority of considerable importance when using the machine, for the benefit of both social coexistence and the environment in which we live. Try not to cause any disturbance to the surrounding area.
2. You must comply with local regulations and provisions for the disposal of packaging, oils, fuel, filters, damaged parts or any elements which have a strong impact on the environment. This waste must not be disposed of as normal waste. It needs to be separated and taken to specified waste disposal centres where the material will be recycled.
3. You must comply with local regulations for the disposal of waste materials after mowing.
4. When disposing, do not pollute the environment with the machine, but hand it over to a disposal centre, in accordance with the local laws in force.

Declaration Of Conformity

Importer and Authorised Representative

Genpower Ltd
Isaac Way, Pembroke Dock, SA72 4RW

Country of Origin: China

Description: Petrol Multi-tool

SKU Code: HYMT5200X-1

Date of Issue: 12/12/2025

The following declaration is issued under the sole responsibility of Genpower Ltd.

We hereby declare that the machine detailed in this declaration complies to all the relevant provisions of the following EC directives and regulations.

Regulations and Directives of Compliance

- 2006/42/EC The Machine Directive
- 2014/30/EU Annex II Electromagnetic Compatibility Directive
- 2016/1628/EC – The Emission of Gaseous and Particulate Pollutants from Internal Combustion Engines
- 2000/14/EC – Noise Emissions in the Environment by Equipment for use outdoors
- REACH EC No 1907/2006 – SVHC
- POP Regulation (EU) 2019/1021 Short-chain chlorinated paraffins (SCCP**, Alkanes C10-13)

Reference to RoHS (recast): Restriction of the Use of Certain Hazardous Substances in Electrical and Electronic Equipment, 2011/65/EU Annex II and its amendment Directive (EU) 2015/863

REFERENCES TO THE RELEVANT HARMONISED SAFETY STANDARDS USED OR REFERENCES TO THE OTHER TECHNICAL SPECIFICATIONS IN RELATION TO WHICH CONFORMITY IS DECLARED:

EN IEC 61000-6-3:2021 - Generic standards - Emission standard for equipment in residential environments

EN ISO 11680-1:2011 - Machinery for forestry — Safety requirements and testing for pole-mounted powered pruners — Part 1: Machines fitted with an integral combustion engine

EN ISO 11806-1:2011 - Agricultural and forestry machinery — Safety requirements and testing for portable, hand-held, powered brush-cutters and grass-trimmers — Part 1: Machines fitted with an integral combustion engine

EN ISO 10517:2019 - Powered hand-held hedge trimmers — Safety

EN ISO 12100:2010 - Safety of machinery — General principles for design — Risk assessment and risk reduction

EN ISO 14982:2009 - Agricultural and forestry machinery — Electromagnetic compatibility — Test methods and acceptance criteria

Statement of Declaration

We the importer and authorised representative of the product described confirm conformity within the provisions of applicable regulations and directives listed within this document.

Signed on Behalf of Genpower Ltd

Identification of Manufacturer: Genpower Ltd, Isaac Way, Pembroke Dock, Pembrokeshire, SA72 4RW, UK.

Name and address of technical documentation holder and EU distributor: Genpower Ltd, 131 Boulevard Pereire, 75017 Paris, France.

Place of Issue: Genpower Ltd

Signatory Name: Roland Llewellyn

Position: Managing Director

RJLlewellyn



Useful Information

Check Out Our YouTube Channel

Our videos on YouTube include:

- Unboxing
- Assembly of your machine
- How to service your machine
- Products in use
- 'How To' videos
- Product features

Go to YouTube and search '**Hyundai Power Products**'.

Warranty

Proof of purchase will be required before you make a warranty claim. Full warranty terms and conditions can be found on the HYUNDAI POWER PRODUCTS website:

www.hyundaipowerproducts.co.uk

Manual Updates

Our manuals are constantly being reviewed and updated. Should you find an error, omission or something unclear, please contact us for assistance. We reserve the right to make any modifications without prior notice whenever necessary.

Our latest manuals are also placed online. All our manuals can be downloaded at:

www.hyundaipowerproducts.co.uk

Returning Your Product

If you are returning your product, please contact the dealer for their returns policy.

Leaving A Review

We work very hard to give all of our customers the best possible service. If you have any problems, before leaving negative feedback, please contact us to give us a chance to resolve the issue. We would be delighted if you left us positive feedback! To leave a review, please go to:

uk.trustpilot.com/review/hyundaipowerequipment.co.uk

Ordering Spare Parts

You can find the spare part you are looking for at **power-spare.com**

Product Record

Information

As soon as you have purchased the machine, we recommend that you fill out the following. If you need to contact an authorised dealer or customer service for information on servicing, you may need to provide the following information.

Date Of Purchase:.....

Dealer Name:.....

Dealer Phone:.....

Model Number:.....

Serial / Batch Number:.....

Contact Us

Need Help? Talk To Our Experts

Our friendly aftersales team will be more than happy to help you.



Phone

Call our team on 01646 687 880



Email

aftersales@genpower.co.uk



Online Live Chat

Go to www.hyundaipowerproducts.co.uk



Post

Genpower Ltd, Isaac Way, Pembroke Dock, Pembrokeshire, SA72 4RW.



Hyundai Support Website

Go to hyundaisupport.co.uk

HYUNDAI

POWER PRODUCTS



GENUINE PRODUCT OF
HYUNDAI CORPORATION

For Inquiries, Please Contact:
GENPOWER LTD
Isaac Way, London Road,
Pembroke Dock, UK, SA72 4RW.
T: +44 (0) 1646 687 880
E: info@hyundaipowerproducts.co.uk
www.hyundaipowerproducts.co.uk

Imported / Distributed by Genpower Ltd
for the United Kingdom & Ireland

Licensed by Hyundai Corporation Holdings, Korea